

DB2000 SERIES DIGITAL INDICATING CONTROLLER



The DB2000 series is a 96×96mm digital indicating controller with the indicating accuracy of $\pm 0.1\%$ and the control cycle of approximately 0.1 seconds. The configuration of highly functional system is enabled by various options including 2 transmission signal outputs, 2 communications ports and arbitrarily-allocation of digital inputs.

■ FEATURES

● Large easy-to-view 5-digit display

Process value (PV) and set value (SV) are displayed by large easy-to-view 5-digit display indicators. The resolution of 0.1°C is enabled for more than 1000°C .

● Highly-functional operation screen and settings screen

The controller inherits the operation screen and the settings screen adopting the LCD (liquid-crystal-display) which has been familiarized for long time. Furthermore, the screens have become high-definition and highly sophisticated.

● Outstanding controllability

Two types of PID algorithms, the position-type PID algorithm and the speed-type PID algorithm, have been installed. You can select the optimum PID algorithm for an object controlled.

● Versatile control functions provided

Versatile control functions, such as the automatic PID system, which executes control by PID parameters preset at every SV sections, and selection of the 2-output control system from PID system and split system for 2-output types, are available.

● Communications 2-port type provided

Models with 2 communications ports are available. In addition, speeding up and highly-functionalization of communications have been realized. For example, you can use 1 port for high order communications with a personal computer and another port for the communications remote (digital remote) function. The communications protocol can be arbitrarily selected from [MODBUS] and [PRIVATE].

● Transmission signal 2-output type available

2 types of transmission signal output, the high-precision type (0.1% of full scale) and the general type (0.3% of full scale), are available. Transmission signal 2-output types with these 2 transmission signal outputs and models with transmitter power supply are available.



● READY function provided

Although the DB2000 series is the constant value controller, switching to the state (READY) that any control is not wanted is enabled.

In addition, the output value (MV) at READY can be set arbitrarily.

● DI arbitrarily-allocation

When the digital input (DI) is added, arbitrarily-allocation for assigning functions to those DI's is enabled. It is the function enabling allocations such as [READY/RUN] to DI1 and [Manual output operation/Automatic output operation] to DI2.

● Heater disconnection alarm

The heater disconnection alarm can be added to ON-OFF pulse types or SSR drive pulse types only.



By connecting the designated CT externally, the current value of heater is measured and can be indicated on the operation screen.

● Other functions

Various functions including multiple auto-tuning, timer function using the digital input (DI), control loop abnormality alarm and user calibration are built-in.

● Conforming to international safety standards and European directives (CE)

The controller is in conformity with European directives (CE), and is UL and c-UL approved.

● Conforming to RoHS

The controller is an environmental consideration product which does not contain directed hazardous substances such as lead, etc.

MODELS

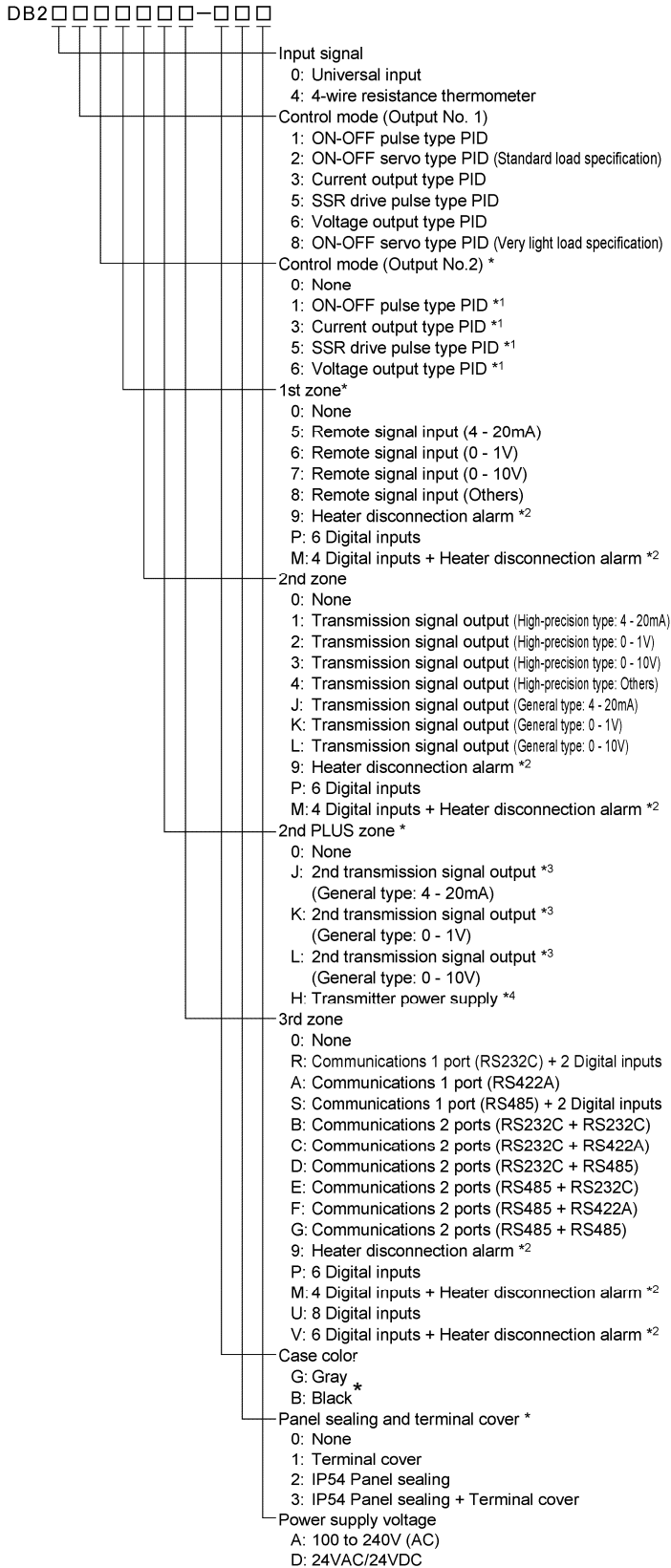

* Option

*1 The control mode (Output No.1) can be selected from 1,3,5 or 6 only.

*2 Only available to the unit having output No.1 (or No.2) of 1 or 5.

Multiple selection in different option zone is not available.
In case of pulse type in both Output No.1 and No.2, output No.1 makes alarm judgement.

*3 It can be selected when the 2nd zone is 1, 2, 3 or 4 only.

*4 It can be selected when the 2nd zone is 0, 1, 2, 3, 4, J, K or L only.

Note: For options common to 1st zone, 2nd zone and 3rd zone, assign them in the order of [9], [P] and [M] from 3rd zone first.

MEASURING RANGES

● Universal input

Measuring ranges		Scale ranges	
Thermocouples	B	0.0 to 1820.0°C	
	R	0.0 to 1760.0°C	
	S	0.0 to 1760.0°C	
	K		-200.0 to 1370.0°C
			0.0 to 600.0°C
	E		-200.0 to 300.0°C
			-270.0 to 1000.0°C
	J		0.0 to 700.0°C
			-270.0 to 300.0°C
	DC voltage	-270.0 to 150.0°C	
		-200.0 to 1200.0°C	
		-200.0 to 900.0°C	
		-200.0 to 400.0°C	
		-100.0 to 200.0°C	
		-270.0 to 400.0°C	
		-200.0 to 200.0°C	
		WRe5-WRe26	0.0 to 2310.0°C
W-WRe26		0.0 to 2310.0°C	
NiMo-Ni		-50.0 to 1410.0°C	
CR-AuFe	0.0 to 280.0K		
N	0.0 to 1300.0°C		
PR5-20	0.0 to 1800.0°C		
PtRh40-PtRh20	0.0 to 1880.0°C		
Platine II	0.0 to 1390.0°C		
U	0.0 to 600.0°C		
L	-200.0 to 900.0°C		
DC current	10mV	-10 to 10mV	
	20mV	-20 to 20mV	
	50mV	-50 to 50mV	
	100mV	-100 to 100mV	
	5V	-5 to 5 V	
	10V	-10 to 0 V	
DC current	20mA	0 to 20 mA	
Resistance thermometer	JPt100	-200.0 to 649.0°C	
		-200.0 to 400.0°C	
		-200.0 to 200.0°C	
	Old Pt100	-200.0 to 649.0°C	
		-200.0 to 400.0°C	
		-200.0 to 200.0°C	
JPt50	-200.0 to 649.0°C		
Pt100	-200.0 to 850.0°C		
		-200.0 to 400.0°C	
		-200.0 to 200.0°C	

● 4-wire resistance thermometer

Measuring ranges		Scale ranges	
Resistance thermometer	JPt100	-200.0 to 649.0°C	
		-200.0 to 400.0°C	
		-200.0 to 200.0°C	
	Old Pt100	-200.0 to 649.0°C	
		-200.0 to 400.0°C	
		-200.0 to 200.0°C	
	JPt50	-200.0 to 649.0°C	
	Pt-Co	4.0 to 374.0K	
	Pt100		-200.0 to 850.0°C
			-200.0 to 400.0°C
		-200.0 to 200.0°C	
		-100.0 to 100.0°C	

[Standards]

K, E, J, T, R, S, B, N : IEC584 (1977,1982), JIS C 1602 -1995, JIS C 1605 -1995

WRe5-WRe26, W-WRe26, NiMo-Ni, Platine II,

CR-AuFe, PtRh40-PtRh20: ASTM Vol.14.03

U, L : DIN43710 - 1985

Pt100 : IEC751 (1995), JIS C 1604 -1997

OldPt100 : IEC751 (1983), JIS C 1604 -1989, JIS C 1606 -1989

JPt100 : JIS C 1604 -1981, JIS C 1606 - 1986

JPt50 : JIS C 1604 -1981

■ NAMES OF VARIOUS PARTS



Display

Function keys

1. Operation status (RUN) indication
Lights in operation.
2. Slope (SLOPE) indication
Lights in slope operation of SV.
3. Ready state (READY) indication
Lights during idling.
4. Alarm-standby (WAIT) indication
Lights in alarm-standby status or when alarm is cancelled.
5. Remote (REM) indication
6. Executing set value number (NO.) indication
7. Error (ERR) indication
Lights when sampling of input is abnormal.
8. Auto-tuning operation (AT) indication
Lights in auto-tuning operation.
9. Manual operation (MAN1/MAN2) indication
Lights when the output No.1 or No. 2 is in manual output operation.
16. Process value (PV) indication
17. Set value (SV) indication
18. Alarm activation (AL1 to 4) indication
19. LCD display

10. It is used for switching between the operation screen and the mode screen of Mode 0, or for switching from the settings screen to the mode screen.
11. It is used to switch the operation screen or to switch the settings screen.
12. It is used for switching between the automatic output operation and the manual output operation.
13. It is used for moving the cursor and for selecting a parameter.
14. It is used for changing a setting value (or selecting a parameter) in descending or ascending order.
15. It is used for registering the settings.
20. Engineering port

■ INPUT SPECIFICATIONS

Input type:	Thermocouple B, R, S, K, E, J, T, N, WRe5-WRe26, W-WRe26, NiMo-Ni, CR-AuFe, PR5-20, PtRh40-PtRh20, Platinel II, U, L DC voltage ±10mV, ±20mV, ±50mV, ±100mV, ±5V, ±10V DC current 0 to 20mA Resistance thermometer Pt100, JPt100, Old Pt100, JPt50, Pt-Co
Measuring range:	Thermocouple 28 ranges DC voltage 6 ranges, Direct current 1 range Resistance thermometer 14 ranges *For details, refer to [Measuring ranges].
Accuracy rating:	±0.1% of measuring range ± 1 digit *For details, refer to [Detailed specifications of accuracy ratings].
Reference junction compensation accuracy:	K, E, J, T, N, Platinel II --- ±0.5°C or a value equivalent to ±20μV, whichever is greater (at ambient temperature of 23°C ± 10°C) Others --- ±1.0°C or a value equivalent to ±40μV, whichever is greater
Resolution:	Approximately 1/30000
Sampling rate:	Approximately 0.1 seconds
Burnout:	Upscale burnout is only enabled in thermocouple, DC voltage (±50mV or less) and resistance thermometer (3-wire type). For the burnout, the output value of Output No. 1 can be set arbitrarily, the output value of Output No. 2 is fixed at 0% and the high limit alarm is set at ON (for the upscale burnout). *The burnout is disabled in DC voltage (±100mV or more), DC current, resistance temperature (4-wire type).
Input impedance:	Thermocouple 1MΩ or more DC voltage 1MΩ or more DC current Approximately 250Ω
Allowable signal source resistance:	Thermocouple 100Ω or less DC voltage (mV) 100Ω or less DC voltage (V) 300Ω or less
Allowable wire resistance (resistance thermometer):	5Ω or less (same resistance for all wires)
Rated current (resistance thermometer):	Approximately 1mA
Maximum allowable input:	Thermocouple ±20V, DC voltage ±20V DC current ±30mA, ±7.5V Resistance thermometer 500Ω, ±5V
Maximum common mode voltage:	30VAC
Common mode rejection ratio:	130dB or more (50/60Hz)
Normal mode rejection ratio:	50dB or more (50/60Hz)

■ DISPLAY SPECIFICATIONS

Display element:	Upper display LED Lower display LCD (with back light) 108 x 24 dots
Display content:	Upper display PV 5-digit, SV 5-digit, status indications, etc. Lower display MV, output status, setting screens, etc.

■ CONTROL SPECIFICATIONS

Control cycle:	Approx. 0.1 seconds
Output type:	ON-OFF pulse type, ON-OFF servo type, Current output type, SSR drive pulse type, Voltage output type
ON-OFF pulse type:	Output signal ON-OFF pulse conductive signal Contact capacity Resistive load 100 to 240VAC 30VDC 5A or less Inductive load 100 to 240VAC 30VDC 2.5A or less Smallest load 5VDC 10mA or more Contact protection Small CR element built-in ON-OFF pulse cycle 1 to 180 seconds
ON-OFF servo type:	Output signal ON-OFF servo conductive signal Contact capacity of standard load Resistive load 100 to 240VAC 30VDC 5A or less Inductive load 100 to 240VAC 30VDC 2.5A or less Smallest load 5VDC 10mA or more Contact capacity of very light load Resistive load 100 to 240VAC 30VDC 20mA or less Inductive load 100 to 240VAC 30VDC 20mA or less Smallest load 5VDC 1mA or more Feedback resistance 100Ω to 2kΩ Contact protection Small CR element built-in
Current output type:	Output signal 4 to 20mA Load resistance 750Ω or less
SSR drive pulse type:	Output signal ON-OFF pulse voltage signal Output voltage ON voltage 12VDC ± 20% OFF voltage 0.8VDC or less Load current 20mA or less Pulse cycle 1 to 180 seconds
Voltage output type:	Output signal 0 to 10V Output impedance Approx. 10Ω Load resistance 50kΩ or more
Output limiter:	-5.0 to 105.0%
Rate-of-change limiter for output:	0.1 to 100.0%
Output preset:	With P action (Settings of I and D = 0), Output at PV = SV -100.0 to 100.0%
Output deadband:	In case of 2-position control (Setting of P = 0), Setting range 0.1 to 9.9%
Control action:	With direct/reverse selection
Output at PV abnormality:	Over-range, under-range, abnormal internal data
Manual output operation:	Output by manual setting -5.0 to 105.0% MAN → AUTO Balanceless bumpless AUTO → MAN Keeping output at AUTO

■ SETTING SPECIFICATIONS

SV relations:	SV 8 types (maximum 5 digits setting) SV range, SV rate-of-change
Control relations:	PID 8 types P 0 to 999.9% I ∞, 1 to 9999 seconds D 0 to 9999 seconds A.R.W. (Anti reset windup) High limit --- 0 to 100.0% Low limit --- -100 to 0.0%
Output relations:	Output deadband 8 types Output preset 8 types Output limiter 8 types Rate-of-change limiter for output 8 types
Alarm relations:	Alarm value 4 points 8 types, alarm types, alarm deadband

■ ALARM SPECIFICATIONS

Number of alarm points:	4 points
Alarm types:	Absolute value alarm, deviation alarm, absolute value deviation alarm, setting value alarm, output value alarm, control loop abnormality alarm, FAIL, timer
Output signal:	Relay output signal (a contact) 1 common terminal for AL1 and AL2, 1 common terminal for AL3 and AL4 Contact capacity Resistive load 100 to 240VAC 30VDC 3A or less Inductive load 100 to 240VAC 30VDC 1.5A or less Smallest load 5VDC 10mA or more

■ GENERAL SPECIFICATIONS

Rated power voltage:	General power supply specifications 100 to 240VAC 24V Power supply specifications 24VAC/24VDC
Rated power supply frequency:	General power supply specifications 50/60Hz 24V Power supply specification 50/60Hz (24VAC)
Maximum power consumption:	General power supply specifications Without options 100VAC 10VA 240VAC 15VA With options 100VAC 15VA 240VAC 20VA 24V power supply specifications Without options 24VAC 10VA 24VDC 5W With options 24VAC 15VA 24VDC 10W
Working temperature range:	-10 to 50°C
Working humidity range:	10 to 90%RH
Power failure countermeasures:	Settings stored in EEPROM (Rewrite count: One million times or less)
Terminal screws:	M3.5
Insulation resistance:	Between primary terminals and secondary terminals 20MΩ or more (500VDC) Between primary terminals and ground terminal 20MΩ or more (500VDC) Between secondary terminals and ground terminal 20MΩ or more (500VDC) *Primary terminal: Terminals for power supply (100 to 240VAC), control output and alarm output
Withstand voltage:	Between primary terminals and secondary terminals 1500VAC (for 1 minute) Between primary terminals and ground terminal 1500VAC (for 1 minute) Between secondary terminals and ground terminal 500VAC (for 1 minute) *Primary terminal: Terminals for power supply (100 to 240VAC), control output and alarm output
Casing:	Fire-retardant polycarbonate
Color:	Gray or black
Mounting:	Panel mounting
External dimensions:	96 (H) x 96 (W) x 127 (D) *The depth from the front panel is 120mm.
Weight:	Without options Approx. 450g With options Approx. 580g

■ SAFTY STANDARD

CE:	EN61326: 1997 +A1+A2+A3 EN61010-1: 2001 (Overvoltage category II, pollution degree 2) *Under the test conditions of EMC directives, there may be variation of indication value or output value which is equivalent to maximum ±10% or maximum 2mV whichever is greater.
UL:	UL61010-1 2nd edition
c-UL:	CAN/CSA C22.2 No.61010-1-04

■ REFERENCE OPERATING CONDITIONS

Ambient temperature:	23°C ± 2°C
Ambient humidity:	55%RH ± 5% (no dew condensation)
Power voltage:	General power supply specifications 100VAC ± 1% 24V power supply specifications 24VDC ± 1%
Power supply frequency:	General power supply specifications 50/60Hz ± 0.5% 24V power supply specifications DC
Mounting angle:	Forward or backward ±3°, lateral ±3°
Installation height:	Altitude 2000m or below
Vibration:	0m/s ²
Shock:	0m/s ²
Mounting condition:	Single-unit panel mounting (Space above, below, right and left of the unit is needed.)
Wind:	None
External noise:	None
Warm up time:	30 min. or longer

■ NORMAL OPERATING CONDITIONS

Ambient temperature:	-10°C to 50°C (-10°C to 40°C for closed mounting)
Ambient humidity:	10 to 90%RH (no dew condensation)
Power voltage:	General power supply specifications 90 to 264VAC 24V Power supply specifications 21.6 to 26.4VDC/AC
Power supply frequency:	General power supply specifications 50/60Hz ± 2% 24V Power supply specifications DC, 50/60Hz ± 2%
Mounting angle:	Forward or backward ±10°, lateral ±10°
Installation height:	Altitude 2000m or below
Vibration:	2m/s ²
Shock:	0m/s ²
Mounting condition:	Single-unit panel mounting (Space above and below of the unit is needed.)
External noise:	None
Rate of ambient temperature change:	10°C/hour or less

■ TRANSPORT CONDITIONS

Ambient temperature:	-20°C to 60°C
Ambient humidity:	5 to 90%RH (no dew condensation)
Vibration:	4.9m/s ² (10 to 60Hz)
Shock:	392m/s ² Under the condition that the unit is packed for shipment by the factory

■ STORAGE CONDITIONS

Ambient temperature:	-20°C to 60°C For long term storage, the temperature should be 10°C to 30°C.
Ambient humidity:	5 to 90%RH (no dew condensation)
Vibration:	0m/s ²
Shock:	0m/s ² Under the condition that the unit is packed for shipment by the factory

■ OPTIONS

●Transmission signal output

Output a signal corresponding to set value (SV), process value (PV), manipulated value (MV), etc.

Number of output: 1 point
 Output signal: 4 - 20mA (Load resistance 400Ω or less)
 0 - 1V (Output resistance Approx.10Ω, Load resistance 50kΩ or more)
 0 - 10V (Output resistance Approx.10Ω, Load resistance 50kΩ or more)

Output accuracy: High-precision type ±0.1% of full scale
 General type ±0.3% of full scale

●Transmitter power supply

Power voltage: 24VDC ± 10%
 Maximum current capacity: 30mA

●Remote signal input

By using external contacts, switching of remote mode and local mode is enabled. With the remote mode, the setting of SV is enabled by remote signal.

Number of inputs: 1 point
 Input signal: 4 - 20mA (Input impedance Approx.50Ω)
 0 - 1V (Input impedance Approx. 500kΩ)
 0 -10V (Input impedance Approx.100kΩ)

Input accuracy: ±0.1% ± 1digit
 Remote signal input: R/L (Remote/Local)

●Communications interface

With RS232C, RS422A or RS485, the setting and measured values of the controller can be transmitted to a master CPU and various parameters can be set by the master CPU.

Number of communications points: 1 point

Communications type: RS232C, RS422A, RS485
 Communications speed: 2400/4800/9600/19200/38400 bps
 Protocol: MODBUS (RTU), MODBUS (ASCII), PRIVATE

●Heater disconnection alarm

It is the function for detecting heater disconnection by CT input.

Measurement range: 10 to100A AC (50/60Hz)
 Accuracy rating: ±5.0% of full scale ± 1 digit
 Designed CT: Use [CTL-12-S36-8] made by URD Co., Ltd.

●2-output type

2 kinds of output with direct and reverse actions are outputted and simultaneous control of heating/cooling is enabled.

Control cycle: Approx. 0.1 seconds
 Output type: ON-OFF pulse type, Current output type, Voltage output type, SSR drive pulse type
 Any combinations of these types are enabled.
 Control system: PID system

●Digital input (DI)

The following switching is enabled by digital input signal.

Input signal: No-voltage contact, open-collector signal
 External contact capacity:

5VDC 2mA
 Functions:
 1. Selection of executing No. (4 points)
 2. Manual output operation/automatic output operation (2 points)
 3. READY/RUN switching
 4. Holding of PV
 5. Holding of SV slope operation
 6. Resetting of SV slope operation
 7. Start/reset of timer (4 points)
 8. Alarm output cancellation
 9. Preset manual/Automatic output operation

●Panel sealing

By mounting the controller to a panel, it has the panel sealing equivalent to [IP54 compliance].

●Terminal cover

It covers the terminals for safe. The cover is transparent.

■ DETAILED SPECIFICATIONS OF ACCURACY RATINGS

Input type		Accuracy rating	Exceptional specifications
Thermocouple	B	±0.1% ± 1digit	Less than 400°C: Not specified / 400°C to less than 800°C: ±0.2% ± 1 digit
	R, S		0°C to less than 400°C: ±0.2% ± 1 digit
	N		
	K		-200°C to less than 0°C: ±0.2% ± 1digit or the value equivalent to ±60 μV, whichever is greater
	E		-270°C to less than 0°C: ±0.2% ± 1digit or the value equivalent to ±80 μV, whichever is greater
	J		-200°C to less than 0°C: ±0.2% ± 1digit or the value equivalent to ±80 μV, whichever is greater
	T		-270°C to less than 0°C: ±0.2% ± 1digit or the value equivalent to ±40 μV, whichever is greater
	U		-200°C to less than 0°C: ±0.2% ± 1digit or the value equivalent to ±40 μV, whichever is greater
	L		-200°C to less than 0°C: ±0.2% ± 1digit
	WRe5-WRe26		
	W-WRe26		0°C to less than 400°C ±0.3% ± 1 digit
	NiMo-Ni		
	Platinel II		
	CR-AuFe		±0.2% ± 1digit
PR5-20	0°C to less than 100°C: Not specified / 100°C to less than 200°C: ±0.5% ± 1 digit		
PtRh40-PtRh20	0°C to less than 400°C: ±1.5% ± 1 digit / 400°C to less than 800°C: ±0.8% ± 1 digit		
DC voltage / DC current		±0.1% ± 1digit	
Resistance thermometer	Pt100	±0.1% ± 1digit	For the measuring range of [-100°C to 100°C] only: ±0.15% ± 1digit
	Old Pt100		
	JPt100		
	JPt50		
	Pt-Co	±0.15% ± 1digit	4K to less than 20K : ±0.5% ± 1digit / 20K to less than 50K : ±0.3% ± 1digit

* The above ratings are the measurement range conversion accuracies under the reference operating conditions.

For thermocouple inputs, the reference junction compensation accuracy is added.

* K, E, J, T, R, S, B, N : IEC584 (1977 - 1982), JIS C 1602 - 1995, JIS C 1605 - 1995
 WRe5-WRe26, W-WRe26, NiMo-Ni, Platinel II, CR-AuFe, PtRh40-PtRh20 : ASTM Vol.14.03
 U, L : DIN43710 - 1985
 Pt100 : IEC751 (1995), JIS C 1604 - 1997
 Old dPt100 : IEC751 (1983), JIS C 1604 - 1989, JIS C 1606 - 1989
 JPt100 : JIS C 1604-1981, JIS C 1606 - 1986
 JPt50 : JIS C 1604 -1981

WRe5-WRe26, W-WRe26, NiMo-Ni, Platinel II, CR-AuFe, PtRh40-PtRh20 : ASTM Vol.14.03

■ TERMINAL ARRANGEMENT

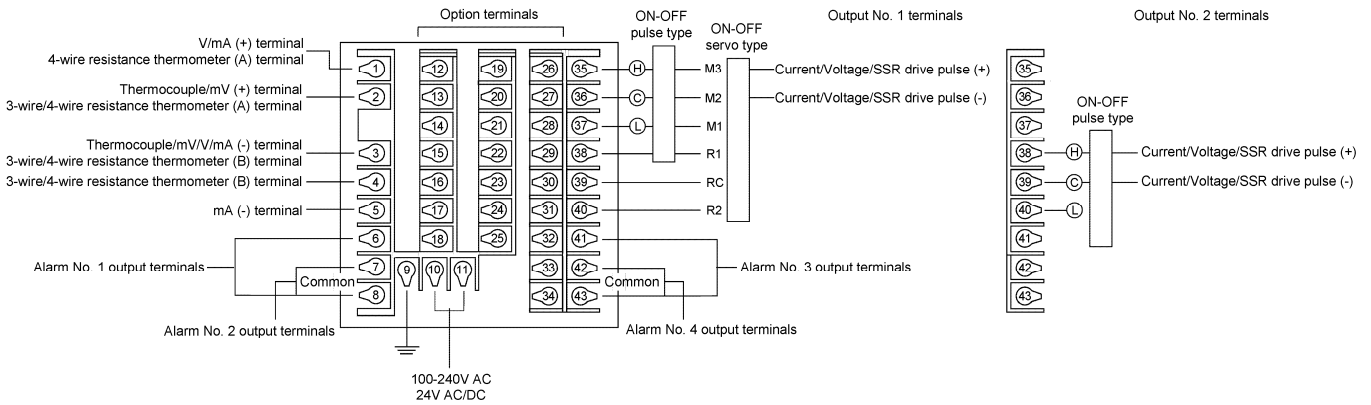

● Option terminals

Options common to each zone

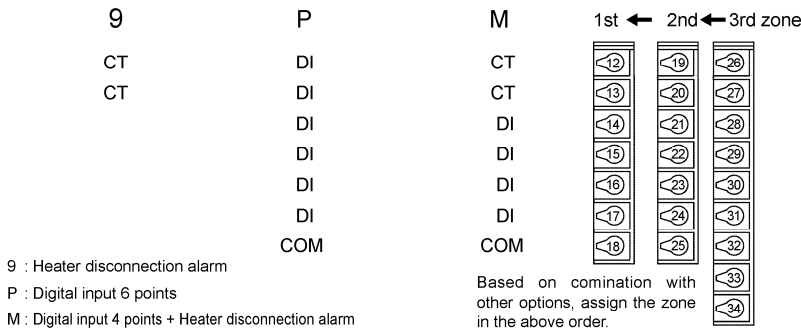

Remote signal input
(1st zone)
5/6/7/8

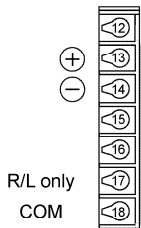

Transmission signal output (2nd zone)

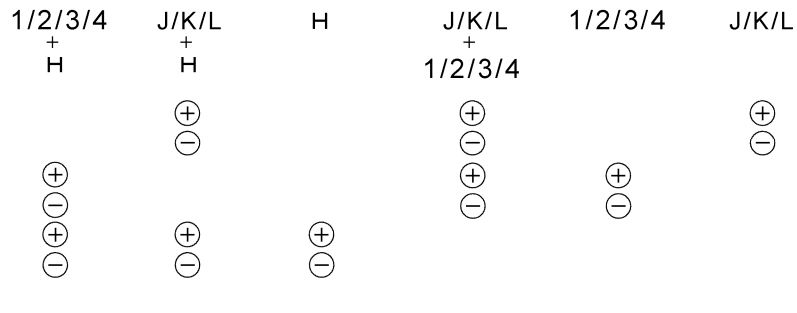

1/2/3/4 : High-precision type J/K/L : General type H : Transmitter power supply

3rd zone

Terminals	R	A	S	B	C	D	E	F	G	U	V
26	RD	RDA	SA	RD1	RD1	RD1	SA1	SA1	SA1	DI	CT
27	SD	RDB	SB	SD1	SD1	SD1	SB1	SB1	SB1	DI	CT
28	SG	SDA	SG	SG1	SG1	SG1	SG1	SG1	SG1	DI	DI
29	DI	SDB	DI	RD2	RDA2	SA2	RD2	RDA2	SA2	DI	DI
30	DI	SG	DI	SD2	RDB2	SB2	SD2	SDB2	SB2	DI	DI
31	R/L only	R/L only	R/L only	SG2	SDA2	SG2	SG2	SDA2	SG2	DI	DI
32	COM	COM	COM		SDB2			SDB2		DI	DI
33				R/L only	R/L only	R/L only	R/L only	R/L only	R/L only	DI	DI
34				COM	COM	COM	COM	COM	COM	COM	COM

R: Communications RS232C + Digital input 2 points

A: Communications RS422A

S: Communications RS485 + Digital input 2 points

B: Communications RS232C + Communications RS232C

C: Communications RS232C + Communications RS422A

D: Communications RS232C + Communications RS485

E: Communications RS485 + Communications RS232C

F: Communications RS485 + Communications RS422A

G: Communications RS485 + Communications RS485

U: Digital input 8 points

V: Digital input 6 points + Heater disconnection alarm

● ABOUT CRIMP STYLE TERMINALS

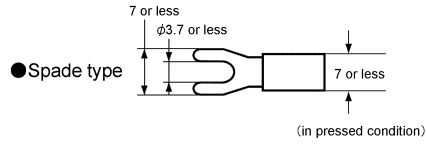
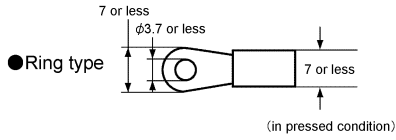

*Use terminal with insulation

■ EXTENAL DIMENSIONES

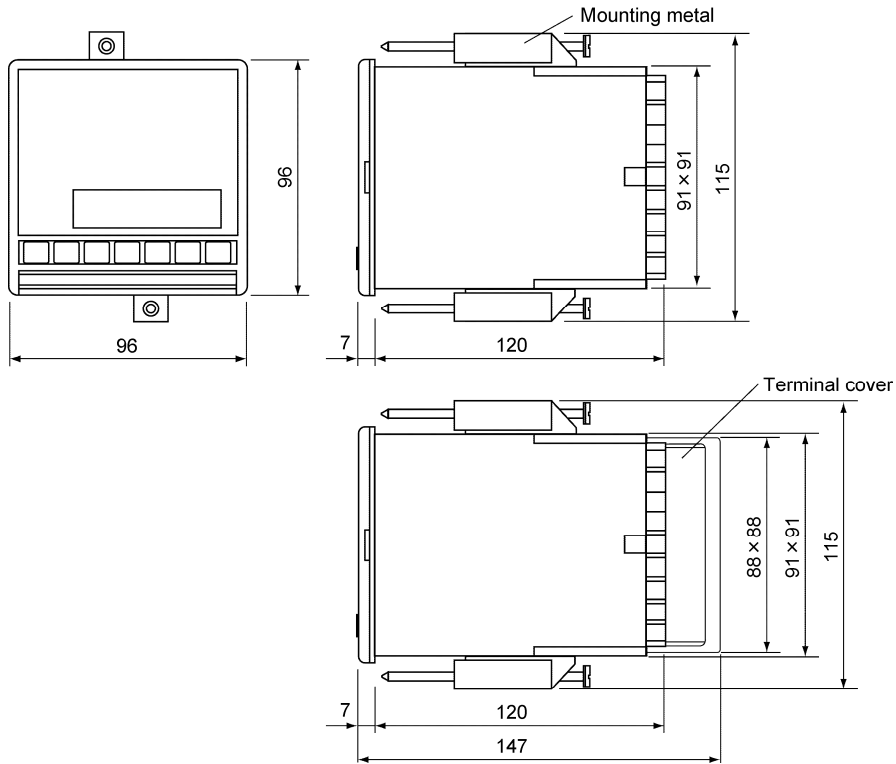

● PANEL CUTOUT

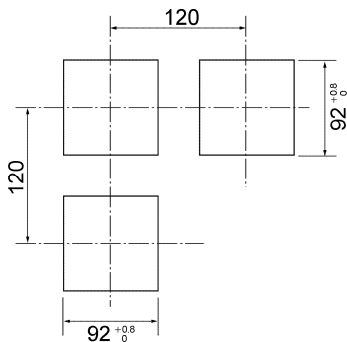

● Closed mounting panel dimensions

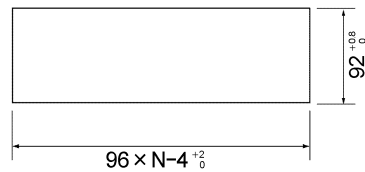

N: Number of mounted instruments

Unit: mm

Specifications subject to change without notice. Printed in Japan (I) 2018. 8. Recycled Paper

CHINO CORPORATION

32-8 KUMANO-CHO, ITABASHI-KU, TOKYO 173-8632

PHONE: +81-3-3956-2171

FAX: +81-3-3956-0915

E-mail: inter@chino.co.jp

Website: <http://www.chino.co.jp>